



# Payment Status Report

## Implementation Guidelines

Version 1.0

## Table of Contents

<b>1</b>	<b>Introduction .....</b>	<b>4</b>
1.1	Coverage .....	5
1.2	Use of these Guidelines .....	6
1.3	Character Set .....	7
1.4	Message structure .....	7
<b>2</b>	<b>Payment Status Report.....</b>	<b>10</b>
2.1	Message structure .....	10
<b>3</b>	<b>Message items description .....</b>	<b>13</b>
	Message root .....	13
1.0	GroupHeader .....	13
1.1	MessageIdentification .....	14
1.2	CreationDateTime.....	14
1.3	Initiatingparty .....	15
2.0	OriginalGroupInformationAndStatus .....	16
2.1	OriginalMessageIdentification.....	16
2.2	OriginalMessageNameIdentification .....	17
2.6	Groupstatus .....	17
2.7	StatusReasonInformation .....	18
2.9	Reason .....	18
2.10	Code.....	19
2.12	AdditionalInformation .....	19
3.0	OriginalPaymentInformationAndStatus .....	20
3.1	OriginalPaymentInformationIdentification .....	21
3.2	OriginalNumberOfTransactions .....	21
3.3	OriginalControlSum .....	21
3.4	PaymentInformationStatus .....	22
3.5	StatusReasonInformation .....	23
3.7	Reason .....	23
3.8	Code.....	24
3.10	AdditionalInformation .....	24
3.11	NumberOfTransactionsPerStatus .....	25
3.12	DetailedNumberOfTransactions .....	25
3.13	DetailedStatus.....	26
3.14	DetailedControlSum .....	26
3.15	TransactionInformationAndStatus .....	27
3.16	StatusIdentification.....	27
3.17	OriginalInstructionIdentification .....	28
3.18	OriginalEndToEndIdentification.....	28

3.19	TransactionStatus .....	29
3.20	StatusReasonInformation .....	30
3.21	Originator.....	30
3.22	Reason .....	31
3.23	Code .....	31
3.25	AdditionalInformation .....	32
3.32	OriginalTransactionReference .....	33
3.34	Amount .....	34
3.35	InstructedAmount.....	35
3.36	EquivalentAmount .....	35
3.37	Amount .....	36
3.38	CurrencyOfTransfer .....	36
3.40	RequestedCollectionDate .....	37
3.41	RequestedExecutionDate .....	37
3.42	CreditorSchemeIdentification.....	38
3.55	PaymentTypeInfoInformation.....	39
3.58	ServiceLevel .....	39
3.59	Code .....	40
3.61	LocalInstrument .....	40
3.62	Code .....	41
3.64	SequenceType.....	41
3.69	MandateRelatedInformation.....	42
3.70	MandateIdentification .....	42
3.88	RemittanceInformation .....	43
3.89	Unstructured.....	43
3.90	Structured .....	44
3.110	CreditorReferenceInformation .....	44
3.111	Type .....	46
3.112	CodeOrProprietary.....	46
3.113	Code.....	47
3.115	Issuer.....	47
3.116	Reference.....	47
3.121	Debtor .....	48
3.122	DebtorAccount.....	48
3.123	DebtorAgent .....	49
3.125	CreditorAgent .....	50
3.127	Creditor.....	51
3.128	CreditorAccount.....	51
<b>4</b>	<b>Statuscodes .....</b>	<b>52</b>
<b>5</b>	<b>List of Status Reason codes.....</b>	<b>53</b>

# 1 Introduction

This document sets out the Belgian Implementation Guidelines for the XML Customer Payment Status Report message ISO 20022 XML - "pain.002.001.03".

The purpose of these Implementation Guidelines is to provide guidance on the use of the Payment Status Report Message sent by the banks to their customers.

These Implementation Guidelines have been developed by Febelfin (the Belgian Financial Sector Federation).

The utmost has been done to make sure the information in this publication is correct. However, Febelfin by no means can be held liable for any loss or damage incurred due to any incorrect or incomplete information mentioned in this publication.

This text is only available in English.

Please contact your bank for any further information.

## 1.1 Coverage

The CustomerPaymentStatusReport message is sent by an instructed agent to the previous party in the payment chain. It is used to inform this party about the positive or negative status of a file (Reporting on GroupHeader) or a negative status of a complete PaymentInformationblock or a transaction. It is also used to report on a pending instruction.

The CustomerPaymentStatusReport message is exchanged between an agent and a non-financial institution customer to provide status information on instructions previously sent. Its usage will always be governed by a bilateral agreement between the agent and the non-financial institution customer.

The CustomerPaymentStatusReport message can be used to provide information about the status (e.g. rejection, acceptance) of the initiation of a credit transfer (SEPA or generic) or a direct debit.

The CustomerPaymentStatusReport message refers to the original instruction(s) by means of references only or by means of references and a set of elements from the original instruction.

The CustomerPaymentStatusReport message can be used in domestic and cross-border scenarios.

## 1.2 Use of these Guidelines

Each item of the CreditTransferStatusReport message is referring to the corresponding index of the item in the XML(ISO 20022) Message Definition Report for Payment Standards – Status Report. This Report can be found on [www.iso20022.org](http://www.iso20022.org), under “Catalogue of XML messages”, with “pain.002.001.03” as reference.

Any gaps in the index numbering are due to the fact that some message elements of the XML message are not supported. The occurrences of a message element (mandatory/optional) can also show a difference between these guidelines and the ISO 20022 XML Message Definition.

The description of each message item contains:

Index	Number referring to the corresponding description in the ISO 20022 XML Message Definition Report for Payment Standards – Payments Status Report
Definition	This contains the definition of the message set or element
Usage	Additional info on how this element must be used
XML Tag	Short name identifying an element within an XML message, which is put between brackets, e.g. <Amt>
Occurrences	<p>This indicates whether an element is optional or mandatory and how many times the element can be repeated. The number of occurrences is shown between square brackets</p> <p>For example:</p> <p>[0..1] shows that the element can be present 0 times or 1 time. The element is optional</p> <p>[1..1] shows that the element can be present only 1 time. The element is mandatory</p> <p>[1..n] shows that the element is mandatory and can be present 1 to n times</p> <p>An element which is part of a set of elements, is mandatory as far as the set it is part of, is present in the message.</p> <p>If only one of several elements may be present, this is indicated by {OR ... OR} in front of the elements concerned</p>
Format	<p>This specifies the values and format allowed</p> <p>Remark: if a tag is used, the correspondent data field may not be left empty. At least one character has to be filled in.</p>
Rules	Any specific rules which could have an impact on the presence or the values of an element

## 1.3 Character Set

The UTF8 character encoding standard must be used in the XML messages.

The Latin character set, commonly used in international communication, must be used.

It contains the following characters:

a b c d e f g h i j k l m n o p q r s t u v w x y z

A B C D E F G H I J K L M N O P Q R S T U V W X Y Z

0 1 2 3 4 5 6 7 8 9

/ - ? : ( ) . , ' +

Space

## 1.4 Message structure

The description of the XML document models can be found in a number of schemes. A specific description language (XSD) is used in those schemes. The schemes make it possible to give a description of the tags in the document, the structure and sequence of those beacons (hierarchy of tags) as well as the codes which are allowed for some specific data, the number of possible cases, the obligatory or optional character of some of the data, etc.

The general XSD for pain.002.001.03 can be downloaded from [www.iso20022.org](http://www.iso20022.org) > Catalogue of ISO 20022 Messages > Payments > Payments Initiation > CustomerCreditTransferStatus ReportV03

A file containing an XML- pain.002.001.03 message has the following structure:

```
<?xml version="1.0" encoding="UTF-8"?>
<Document xmlns="urn:iso:std:iso:20022:tech:xsd:pain.002.001.03"
xmlns:xsi="http://www.w3.org/2001/XMLSchema-instance">
  <CstmrPmtStsRpt>
    message content...
  </CstmrPmtStsRpt>
</Document>
```

A file must contain one single Document (envelope), with one single XML message in it.

The message consists of 3 building blocks:

#### **A. Group Header**

This building block is mandatory and present once. It contains elements such as MessageIdentification, CreationDateAndTime.

#### **B. Original Group Information and Status**

This building block is mandatory and present once. It contains elements such as OriginalMessageIdentification, OriginalMessageNameIdentification, GroupStatus.

#### **C. Original Payment Information And Status**

This building block is optional and repetitive. It contains elements referencing the original instruction (for example OriginalEndToEndIdentification), elements relating to the CustomerPaymentStatusReport (for example StatusReasonInformation). The OriginalPaymentInformationAndStatus block may also transport a set of elements from the original instruction.



The figure below shows the structure of a Payment Status Report Message more into detail.

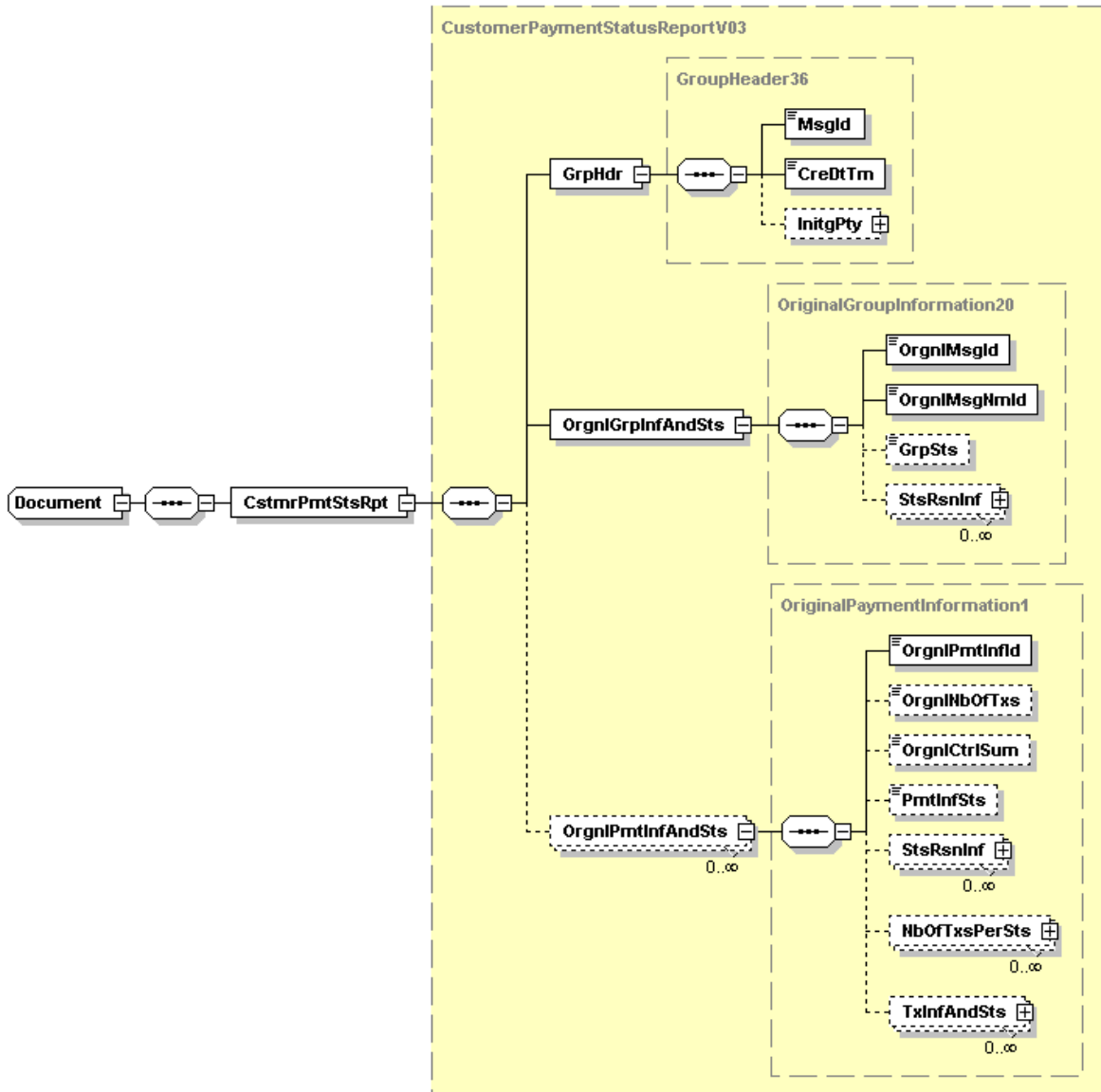

Legend:

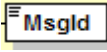
 **Msgld** Box with full-line is a **mandatory** Message Element

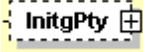
 **InitgPty** Box with dotted line is an **optional** Message Element

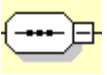
 The Child Elements must appear in the **sequence** mentioned

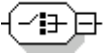
 Only one of the possible Child Elements may be present (choice)

## 2 Payment Status Report

### 2.1 Message structure

The following table gives a summary of the message items to be used for a **Payment Status Report**. A more detailed description of each message item is given in chapter 3 "Message items description"

	[1..1]		+ Message root	<CstmrPmtStsRpt>
1.0	[1..1]		+ GroupHeader	<GrpHdr>
1.1	[1..1]		++ MessageIdentification	<MsgId>
1.2	[1..1]		++ CreationDateTime	<CreDtTm>
1.3	[0..1]		++ InitiatingParty	<InitgPty>
	[0..1]		+++ Identification	<Id>
	[1..1]		++++ OrganisationIdentification	<OrgId>
	[0..1]		+++++ BICOrBEI	<BICOrBEI>
2.0	[1..1]		+ OriginalGroupInformationAndStatus	<OrgnlGrpInfAndSts>
2.1	[1..1]		++ OriginalMessageIdentification	<OrgnlMsgId>
2.2	[1..1]		++ OriginalMessageNameIdentification	<OrgnlMsgNmId>
2.6	[0..1]		++ GroupStatus	<GrpSts>
2.7	[0..n]		++ StatusReasonInformation	<StsRsnInf>
2.9	[0..1]		+++ Reason	<Rsn>
2.10	[1..1]		++++ Code	<Cd>
2.12	[0..n]		+++ AdditionalInformation	<AddtlInf>
3.0	[0..n]		+ OriginalPaymentInformationAndStatus	<OrgnlPmtInfAndSts>
3.1	[1..1]		++ OriginalPaymentInformationIdentification	<OrgnlPmtInfId>
3.2	[0..1]		++ OriginalNumberOfTransactions	<OrgnlNbOfTx>
3.3	[0..1]		++ OriginalControlSum	<OrgnlCtrlSum>
3.4	[0..1]		++ PaymentInformationStatus	<PmtInfSts>
3.5	[0..n]		++ StatusReasonInformation	<StsRsnInf>
3.7	[0..1]		+++ Reason	<Rsn>
3.8	[1..1]		++++ Code	<Cd>
3.10	[0..n]		+++ AdditionalInformation	<AddtlInf>
3.11	[0..n]		++ NumberOfTransactionsPerStatus	<NbOfTxPerSts>
3.12	[1..1]		+++ DetailedNumberOfTransactions	<DtldNbOfTx>
3.13	[1..1]		+++ DetailedStatus	<DtldSts>
3.14	[0..1]		+++ DetailedControlSum	<DtldCtrlSum>
3.15	[0..n]		++ TransactionInformationAndStatus	<TxInfAndSts>
3.16	[0..1]		+++ StatusIdentification	<StsId>
3.17	[0..1]		+++ OriginalInstructionIdentification	<OrgnlInstrId>
3.18	[0..1]		+++ OriginalEndToEndIdentification	<OrgnlEndToEndId>
3.19	[0..1]		+++ TransactionStatus	<TxSts>
3.20	[0..n]		+++ StatusReasonInformation	<StsRsnInf>
3.21	[0..1]		++++ Originator	<Orgtr>
3.22	[0..1]		++++ Reason	<Rsn>
3.23	[1..1]		+++++ Code	<Cd>
3.25	[0..n]		++++ AdditionalInformation	<AddtlInf>
3.32	[0..1]		+++ OriginalTransactionReference	<OrgnlTxRef>

3.34	[0..1]		++++ Amount	<Amt>
3.35	[1..1]	{Or	+++++ InstructedAmount	<InstdAmt Ccy="AAA">
3.36	[1..1]	Or}	+++++ EquivalentAmount	<EqvtAmt>
3.37	[1..1]		++++++ Amount	<Amt Ccy="AAA">
3.38	[1..1]		++++++ CurrencyOfTransfer	<CcyOfTrf>
3.40	[0..1]		++++ RequestedCollectionDate	<ReqdColltnDt>
3.41	[0..1]		++++ RequestedExecutionDate	<ReqdExctnDt>
3.42	[0..1]		++++ CreditorSchemeIdentification	<CdtrSchmId>
3.55	[0..1]		++++ PaymentTypeInfoInformation	<PmtTpInf>
3.58	[0..1]		+++++ Service Level	<SvcLvl>
3.59	[1..1]		++++++ Code	<Cd>
3.61	[0..1]		+++++ Local Instrument	<LclInstrm>
3.62	[1..1]		++++++ Code	<Cd>
3.64	[0..1]		+++++ SequenceType	<SeqTp>
3.69	[0..1]		++++ MandateRelatedInformation	<MndtRltdInf>
3.70	[0..1]		+++++ MandateIdentification	<MndtId>
3.88	[0..1]		++++ RemittanceInformation	<RmtInf>
3.89	[0..1]		+++++ Unstructured	<Ustrd>
3.90	[0..1]		+++++ Structured	<Strd>
3.110	[0..1]		++++++ CreditorReferenceInformation	<CdtrRefInf>
3.111	[0..1]		+++++++ Type	<Tp>
3.112	[1..1]		+++++++ CodeOrProprietary	<CdOrPrtry>
3.113	[1..1]		+++++++ Code	<Cd>
3.115	[0..1]		+++++++ Issuer	<Issr>
3.116	[0..1]		+++++ Reference	<Ref>
3.121	[0..1]		++++ Debtor	<Dbtr>
	[0..1]		+++++ Name	<Nm>
3.122	[0..1]		++++ DebtorAccount	<DbtrAcct>
	[1..1]		+++++ Identification	<Id>
	[1..1]	{Or	+++++ IBAN	<IBAN>
	[1..1]	Or}	+++++ Other	<Othr>
	[1..1]		+++++++ Identification	<Id>
	[0..1]		+++++ Currency	<Ccy>
3.123	[0..1]		++++ DebtorAgent	<DbtrAgt>
	[1..1]		+++++ FinancialInstitutionIdentification	<FinInstnId>
	[0..1]		+++++ BIC	<BIC>
3.125	[0..1]		++++ CreditorAgent	<CdtrAgt>
	[1..1]		+++++ FinancialInstitutionIdentification	<FinInstnId>
	[0..1]		+++++ BIC	<BIC>
	[0..1]		+++++ ClearingSystemMemberIdentification	<ClrSysMmbId>
	[0..1]		+++++ ClearingSystemIdentification	<ClrSysId>
	[1..1]		+++++++ Code	<Cd>
	[1..1]		+++++++ MemberIdentification	<MmbId>
	[0..1]		+++++++ Name	<Nm>
	[0..1]		+++++++ PostalAddress	<PstlAdr>
	[0..1]		+++++++ Country	<Ctry>
	[0..2]		+++++++ AddressLine	<AdrLine>
3.127	[0..1]		++++ Creditor	<Cdtr>
	[0..1]		+++++ Name	<Nm>

3.128	[0..1]		++++ CreditorAccount	<CdtrAcct>
	1..1		+++++ Identification	<Id>
	1..1	{Or	+++++++ IBAN	<IBAN>
	1..1	Or}	+++++++ Other	<Othr>
	1..1		+++++++ Identification	<Id>

### 3 Message items description

#### Message root

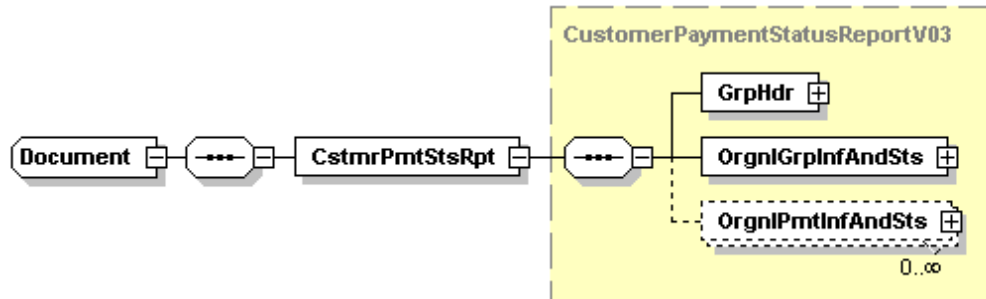

XML Tag: <CstmrPmtStsRpt>

Occurrence: [1..1]

#### 1.0 GroupHeader

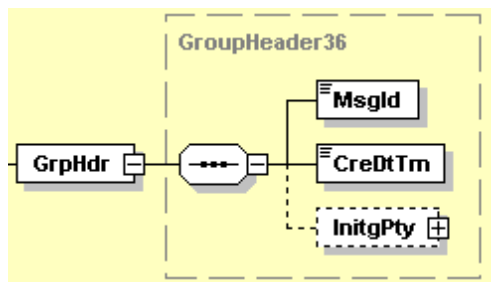

**Definition:** Set of characteristics shared by all individual transactions included in the status report message.

XML Tag: <GrpHdr>

Occurrences: [1..1]

Format: /

Rules: /

## 1.1 MessageIdentification

**MsgId**

**Definition:** Point to point reference, as assigned by the instructing party, and sent to the next party in the chain to unambiguously identify the message.

**Usage:** The instructing party has to make sure that 'MessageIdentification' is unique per instructed party for a pre-agreed period.

**XML Tag:** <MsgId>

**Occurrences:** [1..1]

**Format:** Max35Text

**Rules:** /

## 1.2 CreationDateTime

**CreDtTm**

**Definition:** Date and time at which the message was created.

**XML Tag:** <CreDtTm>

**Occurrences:** [1..1]

**Format:** ISODateTime

**Rules:** /

### 1.3 Initiatingparty

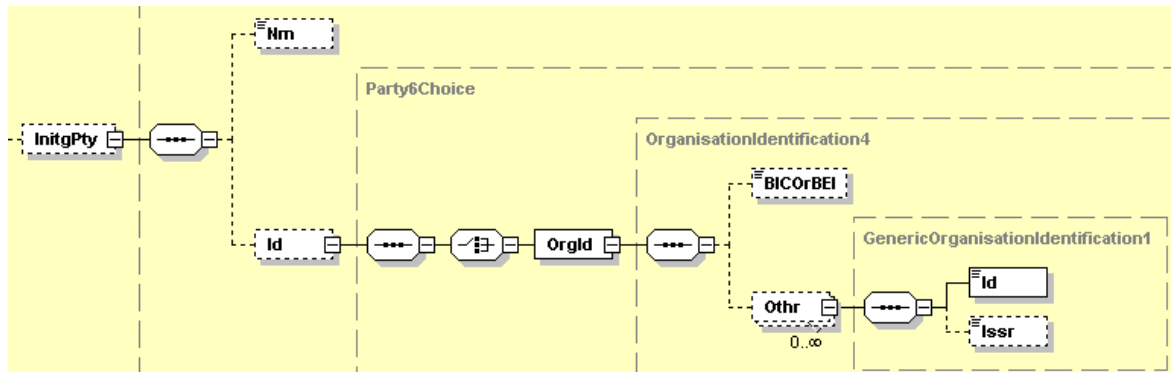

**Definition:** Party that initiates the status message.

**XML Tag:** <InitgPty>

**Occurrences:** [0..1]

**Format:** The message item consists of the following elements:

Name	XML Tag	Occ.
Name	<Nm>	[0..1]
Identification	<Id>	[0..1]
OrganisationIdentification	<OrgId>	[1..1]
BICOrBEI	<BICOrBEI>	[0..1]
Other	<Othr>	[0..n]
Identification	<Id>	[1..1]
Issuer	<Issr>	[0..1]

**Rules:** Either Name or Identification or both can be used.  
Name is limited to 70 characters.

## 2.0 OriginalGroupInformationAndStatus

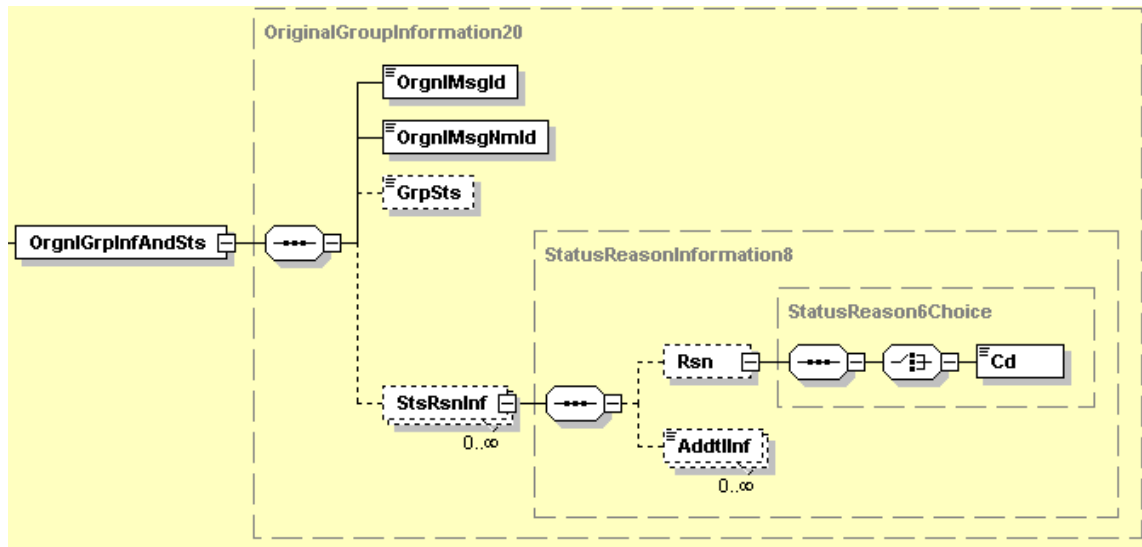

**Definition:** Original group information concerning the group of transactions, to which the status report message refers to.

**XML Tag:** <OrgnlGrpInfAndSts>

**Occurrences:** [1..1]

**Format:** /

**Rules:** If GroupStatus is present and is different from RJCT or PDNG then StatusReasonInformation/AdditionalInformation must be absent.

## 2.1 OriginalMessageIdentification



**Definition:** Point to point reference, as assigned by the original instructing party, to unambiguously identify the original message.

**XML Tag:** <OrgnlMsgId>

**Occurrences:** [1..1]

**Format:** Max35Text

**Rules:** /



## 2.2 OriginalMessageNameIdentification

### OrgnlMsgNmId

**Definition:** Specifies the original message name identifier to which the message refers.

**XML Tag:** <OrgnlMsgNmId>

**Occurrences:** [1..1]

**Format:** Max35Text

**Rules:** /

## 2.6 Groupstatus

### GrpSts

**Definition:** Specifies the status of a group of transactions.

**XML Tag:** <GrpSts>

**Occurrences:** [0..1]

**Format:** One of the following codes can be used:

Code	Name	Definition
ACCP	AcceptedCustomerProfile	Preceding check of technical validation was successful. Customer profile check was also successful.
ACTC	AcceptedTechnicalValidation	Authentication and syntactical and semantical validation are successful.
ACWC	AcceptedWithChange	Instruction is accepted but a change will be made, such as date or remittance not sent.
PART	PartiallyAccepted	A number of transactions have been accepted, whereas another number of transactions have not yet achieved 'accepted' status.
PDNG	Pending	Payment initiation or individual transaction included in the payment initiation is pending. Further checks and status update will be performed.
RCVD	Received	Payment initiation has been received by the receiving agent.
RJCT	Rejected	Payment initiation or individual transaction included in the payment initiation has been rejected.

This is a list of most used codes. For the complete list see [4 StatusCodes](#)

**Rules:** /

## 2.7 StatusReasonInformation

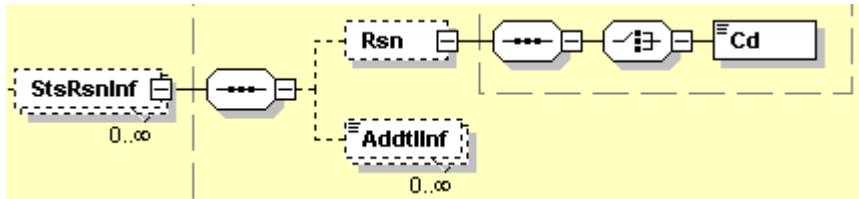

**Definition:** Set of elements used to provide detailed information on the status reason.

**XML Tag:** <StsRsnInf>

**Occurrences:** [0..n]

**Format:** /

**Rules:** 'Status Reason Information' may be present in 'Original Group Information And Status', 'Original Payment Information Status' or 'Transaction Information and Status'.

StatusReasonRule:

If Reason/Code is equal to NARR, then AdditionalInformation must be present.

## 2.9 Reason

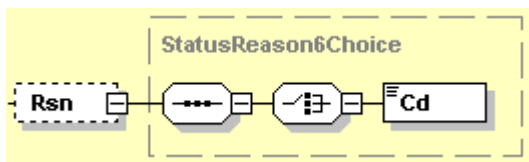

**Definition:** Specifies the reason for the status report.

**XML Tag:** <Rsn>

**Occurrences:** [0..1]

**Format:** This message contains the following element:

Index	Name	XML Tag
2.10	Code	<Cd>

**Rules:** /

## 2.10 Code

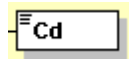

This message item is part of choice 2.9 Reason.

**Definition:** Reason for the status, as published in an external reason code list.  
[See 5 List Of Status Reason Codes](#) in this document or [External Reason Code List](#) on the ISO20022 website.

**XML Tag:** <Cd>

**Occurrences:** [1..1]

**Format:**

**Rules:** /

## 2.12 AdditionalInformation



**Definition:** Further details on the status reason.

**XML Tag:** <AddtlInf>

**Occurrences:** [0..n]

**Format:** maxLength: 105

**Rules:** Additional information can be used for several purposes such as the reporting of repaired information.  
If Reason/Code is equal to NARR, then AdditionalInformation must be present.

### 3.0 OriginalPaymentInformationAndStatus

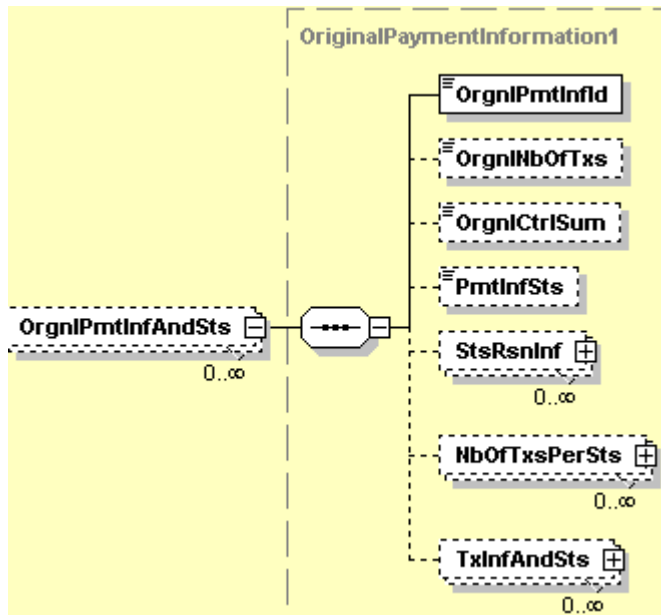

**Definition:** Information concerning the original payment information, to which the status report message refers.

**XML Tag:** <OrgnlPmtInfAndSts>

**Occurrences:** [0..n]

**Format:** /

**Rules:** PaymentInformationStatusAcceptedRule

If OriginalPaymentInformationAndStatus/PaymentInformationStatus is present and is equal to ACTC, ACCP, ACSP, ACSC or ACWC, then TransactionInformationAndStatus/TransactionStatus must be different from RJCT.

PaymentInformationStatusPendingRule

If OriginalPaymentInformationAndStatus/PaymentInformationStatus is present and is equal to PDNG, then TransactionInformationAndStatus/TransactionStatus must be different from RJCT.

PaymentInformationStatusReceivedRule

If OriginalPaymentInformationAndStatus/PaymentInformationStatus is present and is equal to RCVD, then TransactionInformationAndStatus/TransactionStatus is not allowed.

PaymentInformationStatusRejectedRule

If OriginalPaymentInformationAndStatus/PaymentInformationStatus is present and is equal to RJCT, then TransactionInformationAndStatus/TransactionStatus, if present, must be equal to RJCT.

### 3.1 OriginalPaymentInformationIdentification



**Definition:** Unique identification, as assigned by the original sending party, to unambiguously identify the original payment information group.

**XML Tag:** <OrgnlPmtInfId>

**Occurrences:** [1..1]

**Format:** Max35Text

**Rules:** /

### 3.2 OriginalNumberOfTransactions

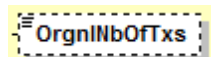

**Definition:** Number of individual transactions contained in the original payment information group.

**XML Tag:** <OrgnlNbOfTx>

**Occurrences:** [0..1]

**Format:** Min 1, Max 15 Digits

**Rules:** /

### 3.3 OriginalControlSum

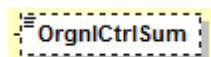

**Definition:** Total of all individual amounts included in the original payment information group, irrespective of currencies.

**XML Tag:** <OrgnlCtrlSum>

**Occurrences:** [0..1]

**Format:** fractionDigits: 17  
totalDigits: 18

**Rules:** /

### 3.4 PaymentInformationStatus



**Definition:** Specifies the status of the payment information group.

**XML Tag:** <PmtInfSts>

**Occurrences:** [0..1]

**Format:** When this message item is present, one of the following values must be used:

Code	Name	Definition
ACCP	AcceptedCustomerProfile	Preceding check of technical validation was successful. Customer profile check was also successful.
ACTC	AcceptedTechnicalValidation	Authentication and syntactical and semantical validation are successful.
ACWC	AcceptedWithChange	Instruction is accepted but a change will be made, such as date or remittance not sent.
PART	PartiallyAccepted	A number of transactions have been accepted, whereas another number of transactions have not yet achieved 'accepted' status.
PDNG	Pending	Payment initiation or individual transaction included in the payment initiation is pending. Further checks and status update will be performed.
RCVD	Received	Payment initiation has been received by the receiving agent.
RJCT	Rejected	Payment initiation or individual transaction included in the payment initiation has been rejected.

This is a list of most used codes. For the complete list see [4 StatusCodes](#)

**Rules:** /

### 3.5 StatusReasonInformation

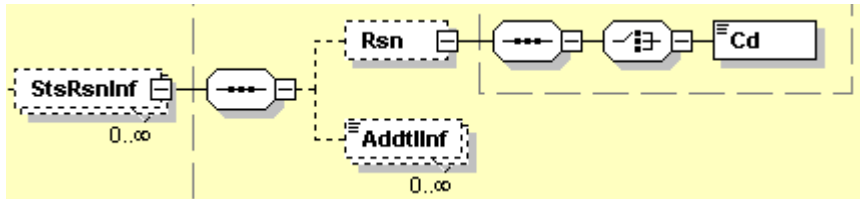

**Definition:** Set of elements used to provide detailed information on the status reason.

**XML Tag:** <StsRsnInf>

**Occurrences:** [0..n]

**Format:** This message item is composed of the following element:

Index	Name	XML Tag	Occ.
3.7	Reason	<Rsn>	[0..1]

**Rules:** 'Status Reason Information' may be present in 'Original Group Information And Status', 'Original Payment Information Status' or 'Transaction Information and Status'.

StatusReasonRule

If Reason/Code is equal to NARR, then AdditionalInformation must be present.

### 3.7 Reason

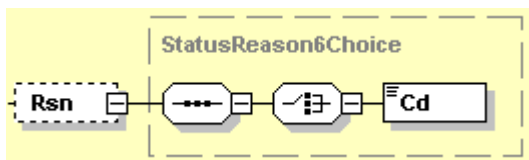

**Definition:** Specifies the reason for the status report.

**XML Tag:** <Rsn>

**Occurrences:** [0..1]

**Format:** This message item is composed of the following element:

Index	Name	XML Tag
3.8	Code	<Cd>

**Rules:** /

### 3.8 Code

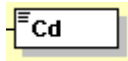

**Definition:** Reason for the status, as published in an external reason code list. [See 5 List Of Status Reason Codes](#) in this document or [External Reason Code List](#) on the ISO20022 website.

**XML Tag:** <Cd>

**Occurrences:** [1..1]

**Format:** /

**Rules:** /

### 3.10 AdditionalInformation



**Definition:** Further details on the status reason.

**XML Tag:** <AddtlInf>

**Occurrences:** [0..n]

**Format:** maxLength: 105

**Rules:** Additional information can be used for several purposes such as the reporting of repaired information.  
StatusReasonRule

If Reason/Code is equal to NARR, then AdditionalInformation must be present.



### 3.11 NumberOfTransactionsPerStatus

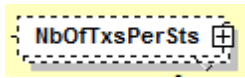

**Definition:** Detailed information on the number of transactions for each identical transaction status.

**XML Tag:** <NbOfTxPerSts>

**Occurrences:** [0..n]

**Format:** This message item is composed of the following element(s):

Index	Message Item	<XML Tag>	Mult.
3.12	DetailedNumberOfTransactions	<DtldNbOfTx>	[1..1]
3.13	DetailedStatus	<DtldSts>	[1..1]
3.14	DetailedControlSum	<DtldCtrlSum>	[0..1]

**Rules:** /

### 3.12 DetailedNumberOfTransactions

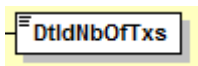

**Definition:** Number of individual transactions contained in the message, detailed per status.

**XML Tag:** <DtldNbOfTx>

**Occurrences:** [1..1]

**Format:** Max15NumericText

**Rules:** /

### 3.13 DetailedStatus

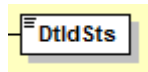

**Definition:** Common transaction status for all individual transactions reported.

**XML Tag:** <DtlDSts>

**Occurrences:** [1..1]

**Format:** One of the following values must be used:

Code	Name	Definition
ACCP	AcceptedCustomerProfile	Preceding check of technical validation was successful. Customer profile check was also successful.
ACTC	AcceptedTechnicalValidation	Authentication and syntactical and semantical validation are successful.
ACWC	AcceptedWithChange	Instruction is accepted but a change will be made, such as date or remittance not sent.
PDNG	Pending	Payment initiation or individual transaction included in the payment initiation is pending. Further checks and status update will be performed.
RJCT	Rejected	Payment initiation or individual transaction included in the payment initiation has been rejected.

This is a list of most used codes. For the complete list see [4 StatusCodes](#)

**Rules:** /

### 3.14 DetailedControlSum

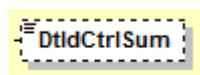

**Definition:** Total of all individual amounts included in the message, irrespective of currencies, detailed per status.

**XML Tag:** <DtlDCtrlSum>

**Occurrences:** [0..1]

**Format:** fractionDigits: 17  
totalDigits: 18

**Rules:** /

### 3.15 TransactionInformationAndStatus

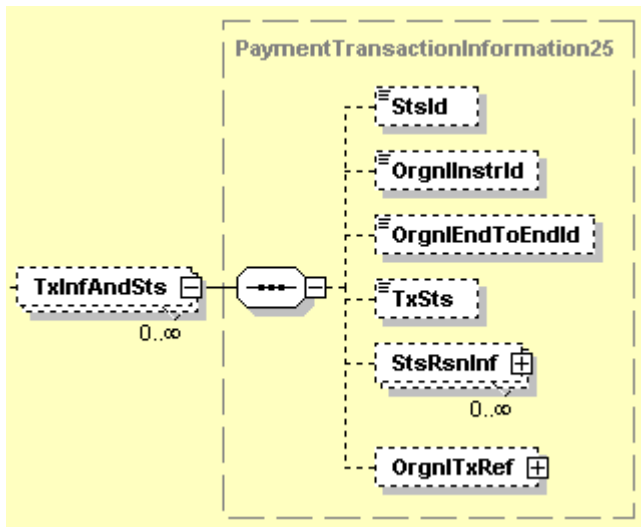

**Definition:** Set of elements used to provide information on the original transactions to which the status report message refers.

**XML Tag:** <TxInfAndSts>

**Occurrences:** [0..n]

**Format:** /

**Rules:** /

### 3.16 StatusIdentification



**Definition:** Unique identification, as assigned by an instructing party for an instructed party, to unambiguously identify the reported status.

**Usage:** The instructing party is the party sending the status message and not the party that sent the original instruction that is being reported on.

**XML Tag:** <StsId>

**Occurrences:** [0..1]

**Format:** Max35Text

**Rules:** /

### 3.17 OriginalInstructionIdentification

**OrgnlInstrId**

**Definition:** Unique identification, as assigned by the original instructing party for the original instructed party, to unambiguously identify the original instruction.

**XML Tag:** <OrgnlInstrId>

**Occurrences:** [0..1]

**Format:** Max35Text

**Rules:** /

### 3.18 OriginalEndToEndIdentification

**OrgnlEndToEndId**

**Definition:** Unique identification, as assigned by the original initiating party, to unambiguously identify the original transaction.

**XML Tag:** <OrgnlEndToEndId>

**Occurrences:** [0..1]

**Format:** Max35Text

**Rules:** /

### 3.19 TransactionStatus

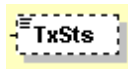

**Definition:** Specifies the status of a transaction, in a coded form.

**XML Tag:** <TxSts>

**Occurrences:** [0..1]

**Format:** Code

Code	Name	Definition
ACCP	AcceptedCustomerProfile	Preceding check of technical validation was successful. Customer profile check was also successful.
ACTC	AcceptedTechnicalValidation	Authentication and syntactical and semantical validation are successful.
ACWC	AcceptedWithChange	Instruction is accepted but a change will be made, such as date or remittance not sent.
PDNG	Pending	Payment initiation or individual transaction included in the payment initiation is pending. Further checks and status update will be performed.
RJCT	Rejected	Payment initiation or individual transaction included in the payment initiation has been rejected.

This is a list of most used codes. For the complete list see [4 StatusCodes](#)

**Rules:** /

### 3.20 StatusReasonInformation

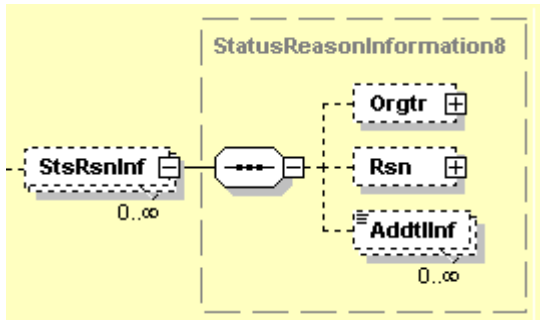

**Definition:** Set of elements used to provide detailed information on the status reason.

**XML Tag:** <StsRsnInf>

**Occurrences:** [0..n]

**Format:** This message item is composed of the following element:

Index	Name	XML Tag
3.22	Reason	<Rsn>

**Rules:** Usage Rule: 'Status Reason Information' may be present in 'Original Group Information And Status', 'Original Payment Information Status' or 'Transaction Information and Status'.StatusReasonRule.  
If Reason/Code is equal to NARR, then AdditionalInformation must be present.

### 3.21 Originator

**Definition:** Party that issues the status.

**XML Tag:** <Orgtr>

**Occurrences:** [0..1]

**Format:** This message item is composed of the following element:

Index	Name	<XML Tag>
	Name	<Nm>

**Rules:** /

### 3.22 Reason

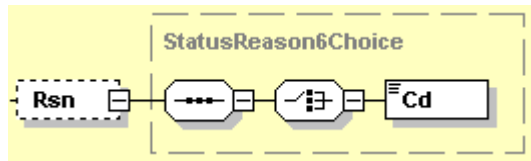

**Definition:** Specifies the reason for the status report.

**XML Tag:** <Rsn>

**Occurrences:** [0..1]

**Format:** This message item is composed of the following element:

Index	Name	XML Tag
3.23	Code	<Cd>

**Rules:** /

### 3.23 Code



**Definition:** Reason for the status, as published in an external reason code list.  
[See 5 List Of Status Reason Codes](#) in this document or [External Reason Code List](#) on the ISO20022 website.

**XML Tag:** <Cd>

**Occurrences :** [1..1]

**Format:** /

**Rules:** /

### 3.25 AdditionalInformation



**Definition:** Further details on the status reason.

**XML Tag:** <AddtlInf>

**Occurrences:** [0..n]

**Format:** maxLength: 105

**Rules:** Additional information can be used for several purposes such as the reporting of repaired information.  
Usage: If Reason/Code is equal to NARR, then AdditionalInformation must be present.



### 3.32 OriginalTransactionReference

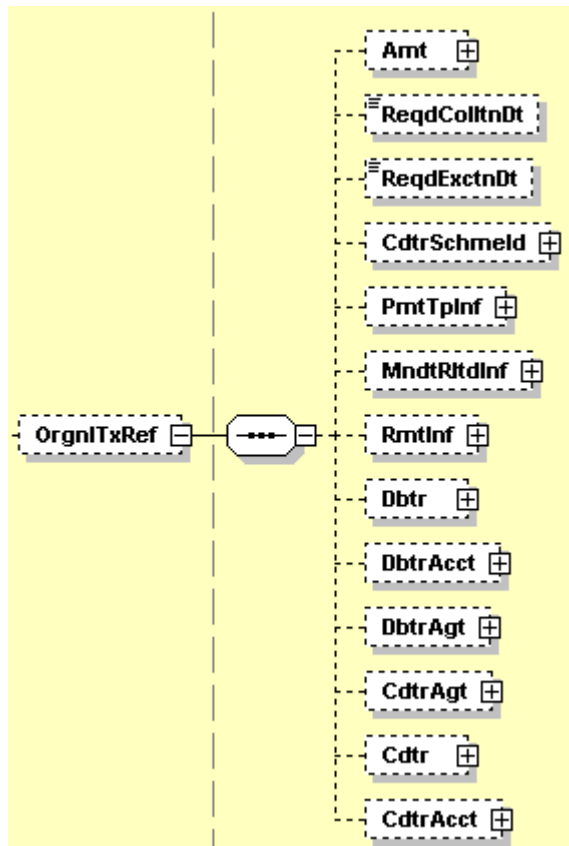

**Definition:** Set of key elements used to identify the original transaction that is being referred to.

**XML Tag:** <OrgnlTxRef>

**Occurrences:** [0..1]

**Format:** This message item is composed of the following element(s):

Index	Name	XML Tag	Occ.
3.34	Amount	<Amt>	[0..1]
3.40	RequestedCollectionDate	<ReqdColltnDt>	[0..1]
3.41	RequestedExecutionDate	<ReqdExctnDt>	[0..1]
3.42	CreditorSchemeIdentification	<CdtrSchmeId>	[0..1]
3.55	PaymentTypeInformation	<PmtTpInf>	[0..1]
3.69	MandateRelatedInformation	<MndtRltdInf>	[0..1]
3.88	RemittanceInformation	<RmtInf>	[0..1]
3.121	Debtor	<Dbtr>	[0..1]
3.122	DebtorAccount	<DbtrAcct>	[0..1]
3.123	DebtorAgent	<DbtrAgt>	[0..1]
3.125	CreditorAgent	<CdtrAgt>	[0..1]

3.127	Creditor	<Cdtr>	[0..1]
3.128	CreditorAccount	<CdtrAcct>	[0..1]

Rules: /

### 3.34 Amount

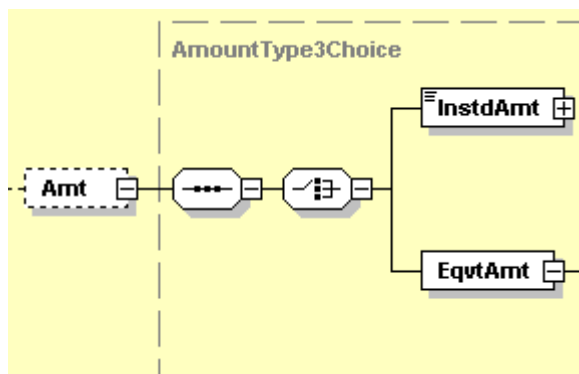

**Definition:** Amount of money to be moved between the debtor and creditor, before deduction of charges, expressed in the currency as ordered by the initiating party.

**XML Tag:** <Amt>

**Occurrences:** [0..1]

**Format:** This message item is composed of one of the following elements:

Index	Name	Tag Name	Occ.
3.35	InstructedAmount	<InstdAmt>	[1..1]
3.36	EquivalentAmount	<EqvtAmt>	[1..1]

Rules: /

### 3.35 InstructedAmount



This message item is part of choice 3.34 Amount.

**Definition:** Amount of money to be moved between the debtor and creditor, before deduction of charges, expressed in the currency as ordered by the initiating party.

**XML Tag:** <InstdAmt>

**Occurrences:** [1..1]

**Format:** Maximum 11 digits for European Credit Transfers, two of which for the fractional part and excluding the decimal separator. E.g.: 999999999.99

Maximum 15 digits for other Credit Transfers, two of which for the fractional part and including the decimal separator. E.g.: 999999999999.99

Decimal separator is "."

Currency is explicit and included into the XML-tag.

**Rules:** /

### 3.36 EquivalentAmount

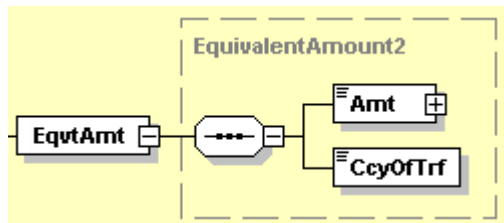

**Definition:** Amount of money to be moved between the debtor and creditor, expressed in the currency of the debtor's account, and the currency in which the amount is to be moved.

**XML Tag:** <EqvtAmt>

**Occurrences:** [1..1]

**Format:** This message item is composed of the following elements:

Index	Name	Tag Name	Occ.
3.37	Amount	<Amt>	[1..1]
3.38	CurrencyOfTransfer	<CcyOfTrf>	[1..1]

**Rules:** /

### 3.37 Amount



**Definition:** Amount of money to be moved between debtor and creditor, before deduction of charges, expressed in the currency of the debtor's account, and to be moved in a different currency.

Usage: The first agent will convert the equivalent amount into the amount to be moved

**XML Tag:** <Amt>

**Occurrences:** [1..1]

**Format:** fractionDigits: 5  
minInclusive: 0  
totalDigits: 18

**Rules:** Maximum 15 digits for other Credit Transfers, two of which for the fractional part and including the decimal separator. E.g.: 999999999999.99

Decimal separator is "."

Currency is explicit and included into the XML-tag.

### 3.38 CurrencyOfTransfer

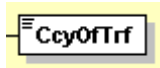

**Definition:** Specifies the currency of the to be transferred amount, which is different from the currency of the debtor's account.

**XML Tag:** <CcyOfTrf>

**Occurrences:** [1..1]

**Format:** /

**Rules:** /

### 3.40 RequestedCollectionDate



**Definition:** Date and time at which the creditor requests that the amount of money is to be collected from the debtor.

**XML Tag:** <ReqdColltnDt>

**Occurrences:** [0..1]

**Format:** ISODate

**Rules:** /

### 3.41 RequestedExecutionDate



**Definition:** Date at which the initiating party requests the clearing agent to process the payment.

**XML Tag:** <ReqdExctnDt>

**Occurrences:** [0..1]

**Format:** ISODate

**Rules:** /

### 3.42 CreditorSchemeIdentification

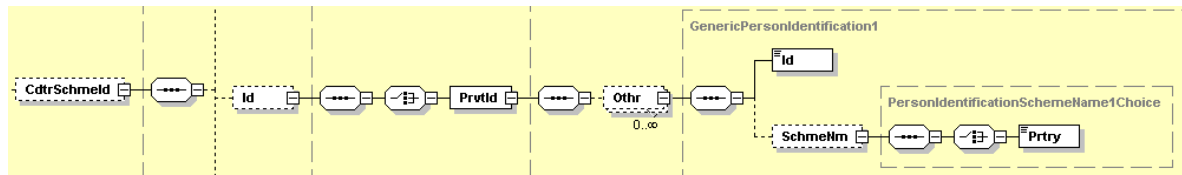

**Definition:** Credit party that signs the mandate.

**XML Tag:** <CdtrSchmeId>

**Occurrences:** [0..1]

**Format:** This message item is composed of the following element(s):

Name	XML Tag	Occ
Identification	<Id>	[1..1]
PrivateIdentification	<PrvtId>	[1..1]
Other	<Othr>	[1..1]
Identification	<Id>	[1..1]
SchemeName	<SchmeNm>	[1..1]
Proprietary	<Prtry>	[1..1]

- Rules:**
- This data element must be present at either 'Payment Information' or 'DirectDebitTransaction' level. It is recommended to use it at 'Payment information' level.
  - SchemeName under 'Other' must specify 'SEPA' as 'Proprietary'.
  - Detail of Identification:
    - Positions 1 and 2 contain the ISO country code
    - Positions 3 and 4 contain the check digits
    - Positions 5 to 7 contain the Creditor Business Code. When the Creditor Business Code is not used, then the value is set to 'ZZZ'
    - Positions 8 up to 35 contain the country-specific identifier

Country specific identifier for Belgium:

- A. Either the Enterprise Number of the Creditor (if it exists)
- B. If no Enterprise Number, the bank will provide to the Creditor a specific number with the following structure:
  - i. Position 8 to 10: protocol code of creditor bank
  - ii. Position 11: "D"
  - iii. Position 12 to 20: increasing number attributed by the bank

### 3.55 PaymentTypeInformation

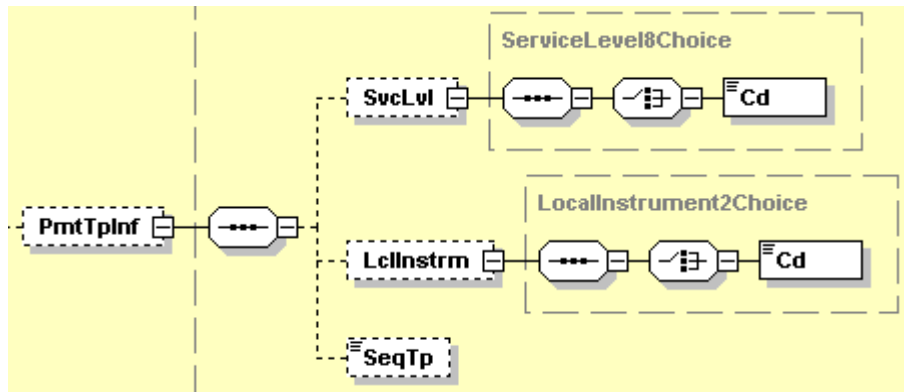

**Definition:** Set of elements used to further specify the type of transaction.

**XML Tag:** <PmtTpInf>

**Occurrences:** [0..1]

**Format:** This message item is composed of the following element(s):

Index	Name	XML Tag	Occ.
3.58	Service Level	<SvcLvl>	[0..1]
3.59	Code	<Cd>	[1..1]
3.61	Local Instrument	<LclInstrm>	[1..1]
3.62	Code	<Cd>	[1..1]
3.64	Sequence Type	<SeqTp>	[1..1]

**Rules:** /

### 3.58 ServiceLevel

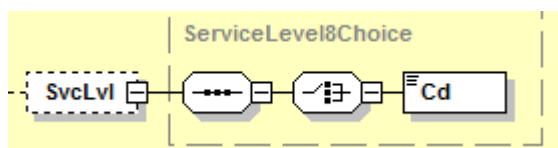

**Definition:** Agreement under which or rules under which the transaction should be processed.

**XML Tag:** <SvcLvl>

**Occurrences:** [0..1]

**Format:** This message item is composed of one of the following element(s):

Index	Name	XML Tag
3.59	Code	<Cd>

**Rules:** /

### 3.59 Code

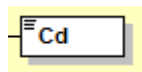

**Definition:** Specifies a pre-agreed service or level of service between the parties, as published in an [external service level code list](#).

**XML Tag:** <Cd>

**Occurrences:** [1..1]

**Format:** maxLength: 4  
minLength: 1

**Rules:** /

### 3.61 LocalInstrument

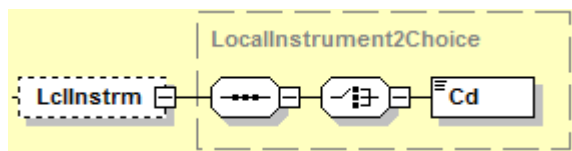

**Definition:** User community specific instrument.  
Usage: This element is used to specify a local instrument, local clearing option and/or further qualify the service or service level.

**XML Tag:** <LclInstrm>

**Occurrences:** [0..1]

**Format:** This message item is composed of one of the following element(s):

Index	Name	XML Tag
3.62	Code	<Cd>

**Rules:** /



### 3.62 Code

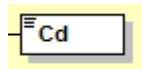

**Definition:** Specifies the local instrument, as published in an [external local instrument code list](#).

**XML Tag:** <Cd>

**Occurrences:** [1..1]

**Format:** maxLength: 35  
minLength: 1

**Rules:** /

### 3.64 SequenceType



**Definition:** Identifies the direct debit sequence, such as first, recurrent, final or one-off.

**XML Tag:** <SeqTp>

**Occurrences:** [0..1]

**Format:** When this message item is present, one of the following values must be used:

Code	Name	Definition
FNAL	Final	Final collection of a series of direct debit instructions.
FRST	First	First collection of a series of direct debit instructions.
OOFF	OneOff	Direct debit instruction where the debtor's authorisation is used to initiate one single direct debit transaction.
RCUR	Recurring	Direct debit instruction where the debtor's authorisation is used for regular direct debit transactions initiated by the creditor.

**Rules:** /

### 3.69 MandateRelatedInformation

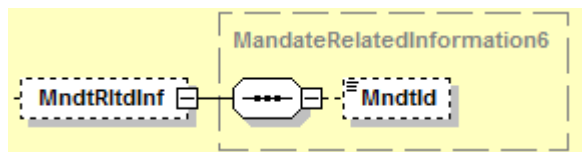

**Definition:** Set of elements used to provide further details of the mandate signed between the creditor and the debtor.

**XML Tag:** <MndtRltdInf>

**Occurrences:** [0..1]

**Format:** This message item is composed of the following element:

Index	Name	XML Tag	Occ.
3.70	MandateIdentification	<MndtId>	[0..1]

**Rules:** /

### 3.70 MandateIdentification



**Definition:** Unique identification, as assigned by the creditor, to unambiguously identify the mandate.

**XML Tag:** <MndtId>

**Occurrences:** [0..1]

**Format:** maxLength: 35, minLength: 1

**Rules:** /

### 3.88 RemittanceInformation

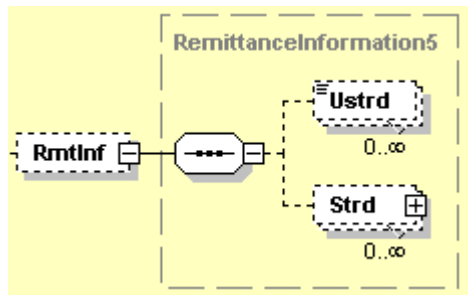

**Definition:** Information supplied to enable the matching of an entry with the items that the transfer is intended to settle, such as commercial invoices in an accounts' receivable system.

**XML Tag:** <RmtInf>

**Occurrences:** [0..1]

**Format:** This message item is composed of the following elements:

Index	Name	XML Tag	Occ.
3.89	Unstructured	<Ustrd>	{Or
3.90	Structured	<Strd>	Or}

**Rules:** Either Structured or Unstructured can be present, but not both.

### 3.89 Unstructured



**Definition:** Information supplied to enable the matching/reconciliation of an entry with the items that the payment is intended to settle, such as commercial invoices in an accounts' receivable system, in an unstructured form.

**XML Tag:** <Ustrd>

**Occurrences:** [0..1]

**Format:** maxLength: 140 minLength: 1

**Rules:** /

### 3.90 Structured



**Definition:** Information supplied to enable the matching/reconciliation of an entry with the items that the payment is intended to settle, such as commercial invoices in an accounts' receivable system, in a structured form.

**XML Tag:** <Strd>

**Occurrences:** [0..1]

**Format:** This message item is composed of the following element:

Index	Name	XML Tag	Occ.
3.110	CreditorReferenceInformation	<CdtrRefInf>	[0..1]

**Rules:** /

### 3.110 CreditorReferenceInformation

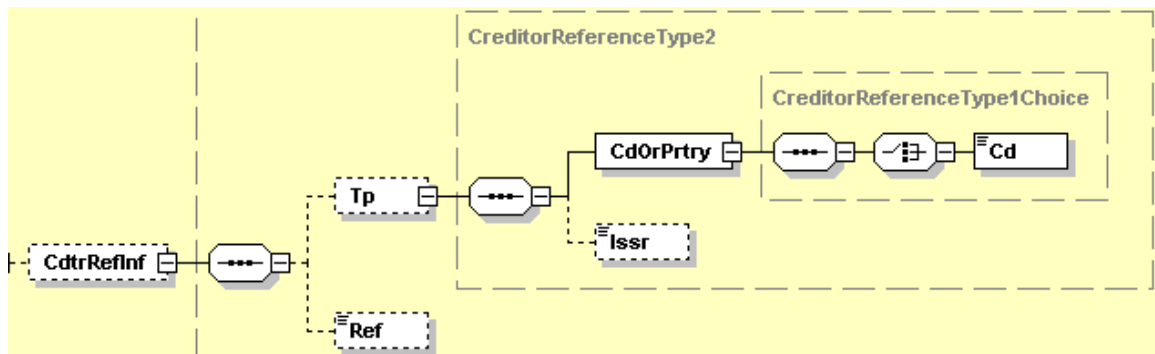

**Definition:** Reference information provided by the creditor to allow the identification of the underlying documents.

**XML Tag:** <CdtrRefInf>

**Occurrences:** [0..1]

**Format:** This message item consists of the following elements:

Index	Name	XML Tag	Occ.	Format
3.111	Type	<Tp>	[1..1]	
3.112	CodeOrProprietary	<CdOrPrtry>	[1..1]	
3.113	Code	<Cd>	[1..1]	Code
3.115	Issuer	<Issr>	[0..1]	max35Text
3.116	Reference	<Ref>	[0..1]	Structured Number

⇒ If the **Belgian Structured Communication** is used, the following value must be used as Code for Type/CodeOrProprietary:

Code	Name	Definition
<b>SCOR</b>	StructuredCommunication Reference	Document is a structured communication reference provided by the creditor for the purpose of identifying the transaction referred to.

The following value must be used as Issuer for Type:

Code	Name	Definition
<b>BBA</b>	The Belgian Bankers' and Stockbroking Firms' Association	The Belgian Bankers' and Stockbroking Firms' Association

⇒ If the **RF Creditor Reference** is used, the following value must be used as **Code** for Type:

Code	Name	Definition
<b>SCOR</b>	StructuredCommunication Reference	Document is a structured communication reference provided by the creditor for the purpose of identifying the transaction referred to.

The following value must be used as **Issuer** for Type:

Code	Name	Definition
<b>ISO</b>	RF Creditor Reference	ISO Structured Creditor reference to remittance information.

⇒ In all other cases **Code** must be SCOR and **Issuer** must not be used.

### 3.111 Type

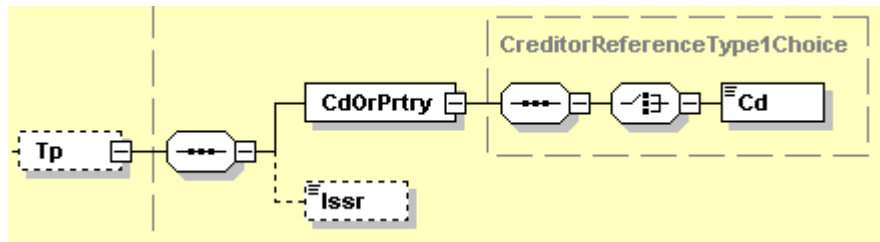

**Definition:** Specifies the type of creditor reference.

**XML Tag:** <Tp>

**Occurrences:** [0..1]

**Format:** This element is composed of the following elements:

Index	Name	XMLTag	Occ.
3.112	CodeOrProprietary	<CdOrPrtry>	[1..1]
3.115	Issuer	<Issr>	[0..1]

**Rules:** /

### 3.112 CodeOrProprietary

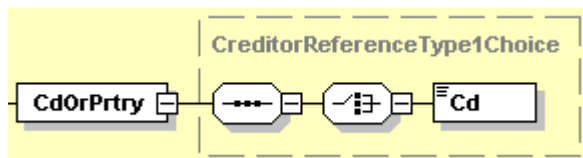

**Definition:** Coded or proprietary format creditor reference type.

**XML Tag:** <CdOrPrtry>

**Occurrences:** [1..1]

**Format:** This message item is composed of the following element:

Index	Name	XML Tag	Occ.
3.113	Code	<Cd>	[1..1]

**Rules:** /

### 3.113 Code

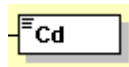

*This message item is part of choice 3.112 CodeOrProprietary.*

**Definition:** Type of creditor reference, in a coded form.

**XML Tag:** <Cd>

**Occurrences:** [1..1]

**Format:** The following value must be used:

Name	Name	Definition
SCOR	StructuredCommunicationReference	Document is a structured communication reference provided by the creditor to identify the referred transaction.

**Rules:** /

### 3.115 Issuer

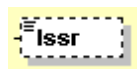

**Definition:** Entity that assigns the credit reference type.

**XML Tag:** <Issr>

**Occurrences:** [0..1]

**Format:** Max35Text

**Rules:** /

### 3.116 Reference

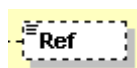

**Definition:** Unique reference, as assigned by the creditor, to unambiguously refer to the payment transaction.

**XML Tag:** <Ref>

**Occurrences:** [0..1]

**Format:** Max35Text

**Rules:** /

### 3.121 Debtor

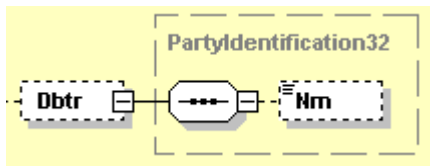

**Definition:** Party that owes an amount of money to the (ultimate) creditor.

**XML Tag:** <Dbtr>

**Occurrences:** [0..1]

**Format:** This message item is composed of the following element(s):

Name	XML Tag	Occ.	Format
Name	<Nm>	[1..1]	Max70Text

**Rules:** /

### 3.122 DebtorAccount

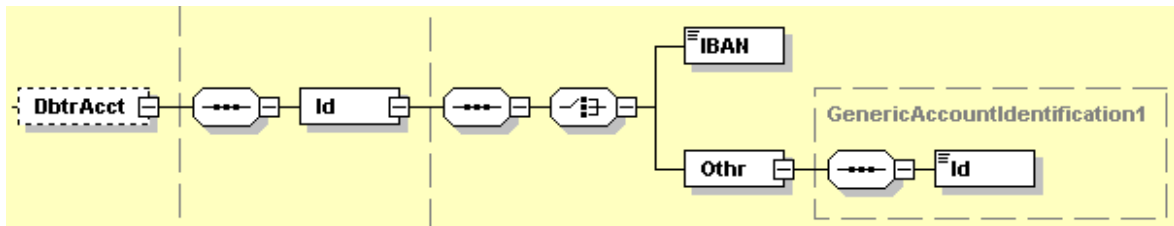

**Definition:** Unambiguous identification of the account of the debtor to which a debit entry will be made as a result of the transaction.

**XML Tag:** <DbtrAcct>

**Occurrences:** [0..1]

**Format:** This message item is composed of the following element(s):

Name	XML Tag	Occ.	Format
Identification	<Id>	[1..1]	
IBAN	<IBAN>	[1..1]{Or	IBAN-format
Other	<Othr>	[1..1] Or}	
Identification	<Id>	[1..1]	Text
Currency	<Ccy>	[0..1]	ISO Currency Code

**Rules:** /



### 3.123 DebtorAgent

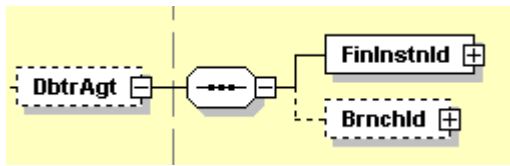

**Definition:** Financial institution servicing an account for the debtor.

**XML Tag:** <DbtrAgt>

**Occurrences:** [0..1]

**Format:** This message item is composed of the following element(s):

Name	XML Tag	Occ.	Format
FinancialInstitutionIdentification	<FinInstnId>	[1..1]	
BIC	<BIC>	[1..1]	BIC-format

**Rules:** /

### 3.125 CreditorAgent

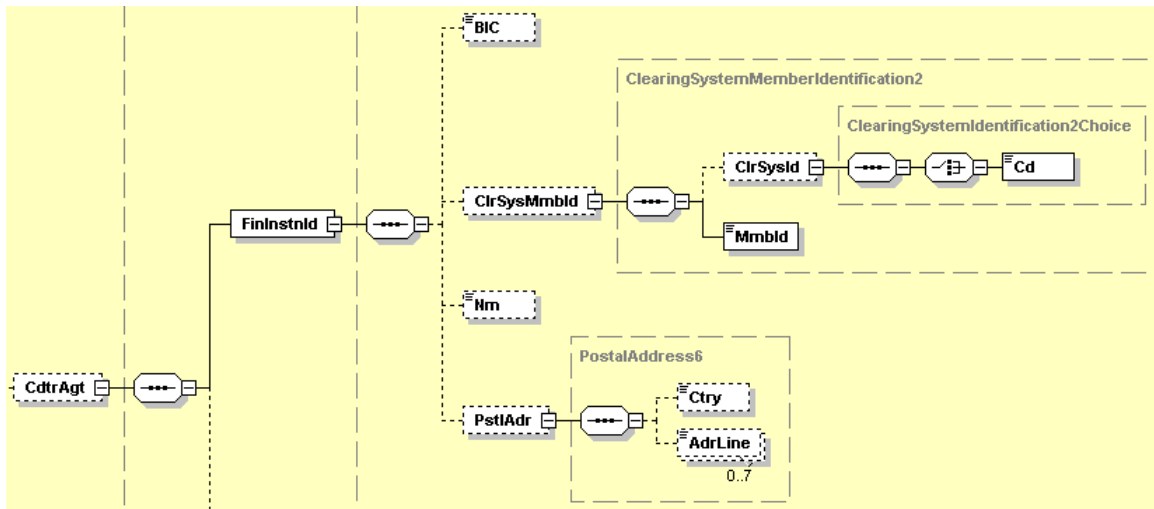

**Definition:** Financial institution servicing an account for the creditor.

**XML Tag:** <CdrAgt>

**Occurrences:** [0..1]

**Format:** This message item is composed of the following element(s):

Name	XML Tag	Occ.	Format
FinancialInstitutionIdentification	<FinInstnId>	[1..1]	
BIC	<BIC>	[0..1]	Identifier
ClearingSystemMemberIdentification	<ClrSysMmbld>	[0..1]	
ClearingSystemIdentification	<ClrSysId>	[0..1]	List of Clearing Systems
Code	<Cd>	[1..1]	Code
MemberIdentification	<Mmbld>	[1..1]	Text
Name	<Nm>	[0..1]	Max70Text
PostalAddress	<PstlAdr>	[0..1]	
Country	<Ctry>	[0..1]	Code
AddressLine	<AdrLine>	[0..2]	Text

**Rules:** /

### 3.127 Creditor

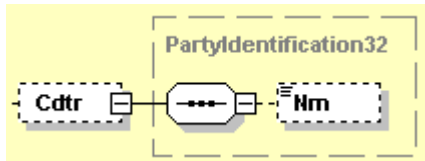

**Definition:** Party to which an amount of money is due.

**XML Tag:** <Cdtr>

**Occurrences:** [0..1]

**Format:** This message item is composed of the following element(s):

Name	XML Tag	Occ.	Format
Name	<Nm>	[1..1]	Max70Text

**Rules:** /

### 3.128 CreditorAccount

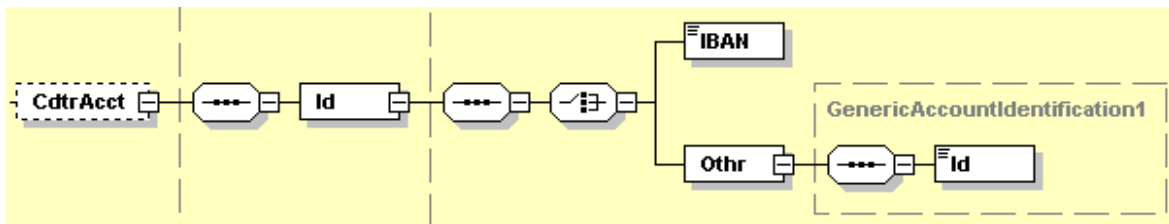

**Definition:** Unambiguous identification of the account of the creditor to which a credit entry will be posted as a result of the payment transaction.

**XML Tag:** <CdtrAcct>

**Occurrences:** [0..1]

**Format:** This message item is composed of the following element(s):

Name	XML Tag	Occ.	Format
Identification	<Id>	[1..1]	
IBAN	<IBAN>	[1..1]{Or	IBAN-format
Other	<Othr>	[1..1] Or}	
Identification	<Id>	[1..1]	Text

**Rules:** /

## 4 Statuscodes

Code	Name	Definition
ACCP	AcceptedCustomerProfile	Preceding check of technical validation was successful. Customer profile check was also successful.
ACSC	AcceptedSettlementCompleted	Settlement on the debtor's account has been completed. Usage : this can be used by the first agent to report to the debtor that the transaction has been completed. Warning : this status is provided for transaction status reasons, not for financial information. It can only be used after bilateral agreement
ACSP	AcceptedSettlementInProgress	All preceding checks such as technical validation and customer profile were successful and therefore the payment initiation has been accepted for execution.
ACTC	AcceptedTechnicalValidation	Authentication and syntactical and semantical validation are successful.
ACWC	AcceptedWithChange	Instruction is accepted but a change will be made, such as date or remittance not sent.
PART	PartiallyAccepted	A number of transactions have been accepted, whereas another number of transactions have not yet achieved 'accepted' status.
PDNG	Pending	Payment initiation or individual transaction included in the payment initiation is pending. Further checks and status update will be performed.
RCVD	Received	Payment initiation has been received by the receiving agent.
RJCT	Rejected	Payment initiation or individual transaction included in the payment initiation has been rejected.

## 5 List of Status Reason codes.

### ExternalStatusReason1Code

	Code	Name	Definition
1	AC01	IncorrectAccountNumber	Account number is invalid or missing. Formerly: Format of the account number specified is not correct.
2	AC02	InvalidDebtorAccountNumber	Debtor account number invalid or missing
3	AC03	InvalidCreditorAccountNumber	Creditor account number invalid or missing
4	AC04	ClosedAccountNumber	Account number specified has been closed on the bank of account's books.
5	AC05	ClosedDebtorAccountNumber	Debtor account number closed
6	AC06	BlockedAccount	Account specified is blocked, prohibiting posting of transactions against it.
7	AC07	ClosedCreditorAccountNumber	Creditor account number closed
8	AC08	InvalidBranchCode	Branch code is invalid or missing
9	AC09	InvalidAccountCurrency	Account currency is invalid or missing
10	AC10	InvalidDebtorAccountCurrency	Debtor account currency is invalid or missing
11	AC11	InvalidCreditorAccountCurrency	Creditor account currency is invalid or missing
12	AC12	InvalidAccountType	Account type missing or invalid. Generic usage if cannot specify between group and payment information levels
13	AC13	InvalidDebtorAccountType	Debtor account type missing or invalid
14	AC14	InvalidCreditorAccountType	Creditor account type missing or invalid
15	AG01	TransactionForbidden	Transaction forbidden on this type of account (formerly NoAgreement)
16	AG02	InvalidBankOperationCode	Bank Operation code specified in the message is not valid for receiver
17	AG03	TransactionNotSupported	Transaction type not supported/authorized on this account
18	AG04	InvalidAgentCountry	Agent country code is missing or invalid. Generic usage if cannot specify between group and payment information levels.
19	AG05	InvalidDebtorAgentCountry	Debtor agent country code is missing or invalid
20	AG06	InvalidCreditorAgentCountry	Creditor agent country code is missing or invalid
21	AG07	UnsuccessfulDirectDebit	Debtor account cannot be debited for a generic reason. Code value may be used in general purposes and as a replacement for AM04 if debtor bank does not reveal its customer's insufficient funds for privacy reasons
22	AG08	InvalidAccessRights	Transaction failed due to invalid or missing user or access right
23	AGNT	IncorrectAgent	Agent in the payment workflow is incorrect

24	AM01	ZeroAmount	Specified message amount is equal to zero
25	AM02	NotAllowedAmount	Specific transaction/message amount is greater than allowed maximum
26	AM03	NotAllowedCurrency	Specified message amount is an non processable currency outside of existing agreement
27	AM04	InsufficientFunds	Amount of funds available to cover specified message amount is insufficient.
28	AM05	Duplication	Duplication
29	AM06	TooLowAmount	Specified transaction amount is less than agreed minimum.
30	AM07	BlockedAmount	Amount of funds available to cover specified message amount is insufficient.
31	AM09	WrongAmount	Amount received is not the amount agreed or expected
32	AM10	InvalidControlSum	Sum of instructed amounts does not equal the control sum.
33	AM11	InvalidTransactionCurrency	Transaction currency is invalid or missing
34	AM12	InvalidAmount	Amount is invalid or missing
35	AM13	AmountExceedsClearing SystemLimit	Transaction amount exceeds limits set by clearing system
36	AM14	AmountExceedsAgreedLimit	Transaction amount exceeds limits agreed between bank and client
37	AM15	AmountBelowClearing SystemMinimum	Transaction amount below minimum set by clearing system
38	AM16	InvalidGroupControlSum	Control Sum at the Group level is invalid
39	AM17	InvalidPaymentInfoControlSum	Control Sum at the Payment Information level is invalid
40	AM18	InvalidNumberOfTransactions	Number of transactions is invalid or missing. Generic usage if cannot specify between group and payment information levels.
41	AM19	InvalidGroupNumberOf Transactions	Number of transactions at the Group level is invalid or missing
42	AM20	InvalidPaymentInfoNumber OfTransactions	Number of transactions at the Payment Information level is invalid
43	BE01	InconsistenWithEndCustomer	Identification of end customer is not consistent with associated account number. (formerly CreditorConsistency).
44	BE04	MissingCreditorAddress	Specification of creditor's address, which is required for payment, is missing/not correct (formerly IncorrectCreditorAddress).
45	BE05	UnrecognisedInitiatingParty	Party who initiated the message is not recognised by the end customer
46	BE06	UnknownEndCustomer	End customer specified is not known at associated Sort/National Bank Code or does no longer exist in the books
47	BE07	MissingDebtorAddress	Specification of debtor's address, which is required for payment, is missing/not correct.
48	BE08	MissingDebtorName	Debtor name is missing

49	BE09	InvalidCountry	Country code is missing or Invalid. Generic usage if cannot specifically identify debtor or creditor
50	BE10	InvalidDebtorCountry	Debtor country code is missing or invalid
51	BE11	InvalidCreditorCountry	Creditor country code is missing or invalid
52	BE12	InvalidCountryOfResidence	Country code of residence is missing or Invalid. Generic usage if cannot specifically identify debtor or creditor
53	BE13	InvalidDebtorCountryOf Residence	Country code of debtor's residence is missing or Invalid
54	BE14	InvalidCreditorCountryOf Residence	Country code of creditor's residence is missing or Invalid
55	BE15	InvalidIdentificationCode	Identification code missing or invalid. Generic usage if cannot specifically identify debtor or creditor.
56	BE16	InvalidDebtorIdentification Code	Debtor or Ultimate Debtor identification code missing or invalid
57	BE17	InvalidCreditorIdentification Code	Creditor or Ultimate Creditor identification code missing or invalid
58	BE18	InvalidContactDetails	Contact details missing or invalid
59	BE19	InvalidChargeBearerCode	Charge bearer code for transaction type is invalid
60	BE20	InvalidNameLength	Name length exceeds local rules for payment type.
61	BE21	MissingName	Name missing or invalid. Generic usage if cannot specifically identify debtor or creditor.
62	BE22	MissingCreditorName	Creditor name is missing
63	CURR	IncorrectCurrency	Currency of the payment is incorrect
64	CUST	RequestedByCustomer	Cancellation requested by the Debtor
65	DS0A	DataSignRequested	Data signature is required.
66	DS0B	UnknownDataSignFormat	Data signature for the format is not available or invalid.
67	DS0C	SignerCertificateRevoked	The signer certificate is revoked.
68	DS0D	SignerCertificateNotValid	The signer certificate is not valid (revoked or not active).
69	DS0E	IncorrectSignerCertificate	The signer certificate is not present.
70	DS0F	SignerCertificationAuthority SignerNotValid	The authority of the signer certification sending the certificate is unknown.
71	DS0G	NotAllowedPayment	Signer is not allowed to sign this operation type.
72	DS0H	NotAllowedAccount	Signer is not allowed to sign for this account.
73	DS0K	NotAllowedNumberOfTransaction	The number of transaction is over the number allowed for this signer.
74	DS10	Signer1CertificateRevoked	The certificate is revoked for the first signer.
75	DS11	Signer1CertificateNotValid	The certificate is not valid (revoked or not active) for the first signer.

76	DS12	IncorrectSigner1Certificate	The certificate is not present for the first signer.
77	DS13	SignerCertificationAuthority Signer1NotValid	The authority of signer certification sending the certificate is unknown for the first signer.
78	DS20	Signer2CertificateRevoked	The certificate is revoked for the second signer.
79	DS21	Signer2CertificateNotValid	The certificate is not valid (revoked or not active) for the second signer.
80	DS22	IncorrectSigner2Certificate	The certificate is not present for the second signer.
81	DS23	SignerCertificationAuthority Signer2NotValid	The authority of signer certification sending the certificate is unknown for the second signer.
82	DT01	InvalidDate	Invalid date (eg, wrong <b>or missing</b> settlement date)
83	DT02	InvalidCreationDate	Invalid creation date and time in Group Header (eg, historic date)
84	DT03	InvalidNonProcessingDate	Invalid non bank processing date (eg, weekend or local public holiday)
85	DT04	FutureDateNotSupported	Future date not supported
86	DT05	InvalidCutOffDate	Associated message, payment information block or transaction was received after agreed processing cut-off date, i.e., date in the past.
87	DT06	ExecutionDateChanged	Execution Date has been modified in order for transaction to be processed
88	DU01	DuplicateMessageID	Message Identification is not unique.
89	DU02	DuplicatePaymentInformationID	Payment Information Block is not unique.
90	DU03	DuplicateTransaction	Transaction is not unique.
91	DU04	DuplicateEndToEndID	End To End ID is not unique.
92	DU05	DuplicateInstructionID	Instruction ID is not unique.
93	DUPL	DuplicatePayment	Payment is a duplicate of another payment
94	ED01	CorrespondentBankNotPossible	Correspondent bank not possible.
95	ED03	BalanceInfoRequest	Balance of payments complementary info is requested
96	ED05	SettlementFailed	Settlement of the transaction has failed.
97	FF01	Invalid File Format	File Format incomplete or invalid
98	FF02	SyntaxError	Syntax error reason is provided as narrative information in the additional reason information.
99	FF03	InvalidPaymentTypeInfoInformation	Payment Type Information is missing or invalid. Generica usage if cannot specify Service Level or Local Instrument code
100	FF04	InvalidServiceLevelCode	Service Level code is missing or invalid
101	FF05	InvalidLocalInstrumentCode	Local Instrument code is missing or invalid
102	FF06	InvalidCategoryPurposeCode	Category Purpose code is missing or invalid
103	FF07	InvalidPurpose	Purpose is missing or invalid



104	FF08	InvalidEndToEndId	End to End Id missing or invalid
105	FF09	InvalidChequeNumber	Cheque number missing or invalid
106	FF10	BankSystemProcessingError	File or transaction cannot be processed due to technical issues at the bank side
107	MD01	NoMandate	No Mandate
108	MD02	MissingMandatoryInformationInMandate	Mandate related information data required by the scheme is missing.
109	MD05	CollectionNotDue	Creditor or creditor's agent should not have collected the direct debit
110	MD06	RefundRequestByEndCustomer	Return of funds requested by end customer
111	MD07	EndCustomerDeceased	End customer is deceased.
112	MS02	NotSpecifiedReasonCustomerGenerated	Reason has not been specified by end customer
113	MS03	NotSpecifiedReasonAgentGenerated	Reason has not been specified by agent.
114	NARR	Narrative	Reason is provided as narrative information in the additional reason information.
115	RC01	BankIdentifierIncorrect	Bank Identifier code specified in the message has an incorrect format (formerly IncorrectFormatForRoutingCode).
116	RC02	InvalidBankIdentifier	Bank identifier is invalid or missing. Generic usage if cannot specify between debit or credit account
117	RC03	InvalidDebtorBankIdentifier	Debtor bank identifier is invalid or missing
118	RC04	InvalidCreditorBankIdentifier	Creditor bank identifier is invalid or missing
119	RC05	InvalidBICIdentifier	BIC identifier is invalid or missing. Generic usage if cannot specify between debit or credit account.
120	RC06	InvalidDebtorBICIdentifier	Debtor BIC identifier is invalid or missing
121	RC07	InvalidCreditorBICIdentifier	Creditor BIC identifier is invalid or missing
122	RC08	InvalidClearingSystemMemberIdentifier	ClearingSystemMemberIdentifier is invalid or missing. Generic usage if cannot specify between debit or credit account
123	RC09	InvalidDebtorClearingSystemMemberIdentifier	Debtor ClearingSystemMember identifier is invalid or missing
124	RC10	InvalidCreditorClearingSystemMemberIdentifier	Creditor ClearingSystemMember identifier is invalid or missing
125	RC11	InvalidIntermediaryAgent	Intermediary Agent is invalid or missing
126	RC12	MissingCreditorSchemeId	Creditor Scheme Id is invalid or missing
127	RF01	NotUniqueTransactionReference	Transaction reference is not unique within the message.
128	RR01	Missing Debtor Account or Identification	Specification of the debtor's account or unique identification needed for reasons of regulatory requirements is insufficient or missing
129	RR02	Missing Debtor Name or Address	Specification of the debtor's name and/or address needed for regulatory requirements is insufficient or missing.

130	RR03	Missing Creditor Name or Address	Specification of the creditor's name and/or address needed for regulatory requirements is insufficient or missing.
131	RR04	Regulatory Reason	Regulatory Reason
132	RR05	RegulatoryInformationInvalid	Regulatory or Central Bank Reporting information missing, incomplete or invalid.
133	RR06	TaxInformationInvalid	Tax information missing, incomplete or invalid.
134	RR07	RemittanceInformationInvalid	Remittance information structure does not comply with rules for payment type.
135	RR08	RemittanceInformation Truncated	Remittance information truncated to comply with rules for payment type.
136	RR09	InvalidStructuredCreditor Reference	Structured creditor reference invalid or missing.
137	RR10	InvalidCharacterSet	Character set supplied not valid for the country and payment type.
138	RR11	InvalidDebtorAgentServiceID	Invalid or missing identification of a bank proprietary service.
139	RR12	InvalidPartyID	Invalid or missing identification required within a particular country or payment type.
140	SL01	Specific Service offered by Debtor Agent	Due to specific service offered by the Debtor Agent
141	SL02	Specific Service offered by Creditor Agent	Due to specific service offered by the Creditor Agent
142	TM01	InvalidCutOffTime Formerly: CutOffTime	Associated message, payment information block, or transaction was received after agreed processing cut-off time.



[www.febelfin.be](http://www.febelfin.be)



Belgian Financial sector Federation

Rue d'Arlon/Aarlenstraat 82 | 1040 Brussels  
T 02 507 68 11 | [info@febelfin.be](mailto:info@febelfin.be) | [www.febelfin.be](http://www.febelfin.be)